



CHNT | Next
CHINT ELECTRIC | series

The Next Reliable Choice

Motor Control & Protection

CHINT•Empower the World



Founded in 1984, CHINT Group is a leader in Chinese industrial electric appliance and new energy sectors. With total assets of 36.5 billion RMB and nearly 30 thousand employees, the company is running business that covers the whole power equipment industrial chain including power generation, transmission, transformation, distribution, and consumption. The company is also operating in the fields of urban rail traffic, energy equipment manufacturing, new energy storage materials, Energy Internet, investment & financing platform, and business incubator. The products have been sold to over 120 countries and regions around the world, and have entered main component markets in Europe, Asia, Middle East, and Africa.

The group ranks among top 500 private enterprises in China, and has been the largest tax payer among all manufacturers in Wenzhou for a few consecutive years. Zhejiang CHINT Electric Appliance Corporation under CHINT Group is the largest company in domestic LV electric appliance industry in terms of production and sales amount, and also the first company running LV electric appliance as main business listed in A-share market. CHINT Solar has built over a hundred photovoltaic power stations around the world, serving as the largest photovoltaic power station investor and operator in all domestic private players.

CHINT has always following the policies of innovation-driven industrial development. It's the first among all competitors to pass ISO9001 quality system certification, ISO 14001 environment system certification, and OHSAS18001 occupational health safety management certification. The group also holds China Compulsory Certificate (CCC), international CB safety certificate, US UL certificate, Finland FI certificate, Belgium CEBEC certificate, Netherland KEMA certificate, and Germany VDE certificate. The group now owns over 1000 domestic and foreign patents, and has led or participate in establishment and revision of over 120 industrial standards. Its HV and LV electric appliances and photovoltaic inverters won Germany Wed Dot Award. CHINT led development of critical manufacturing equipment PECVD, LPCVD, and MOCVD for China's first silicon based thin film photovoltaic cells, which has significantly improved semiconductor equipment manufacturing level in China.

The group has won a number of awards including China Industrial Award, National Quality Management Award, China Excellent Private Science & Technology Enterprise, China Top Ten Machinery Manufacturers with Core Competitiveness, China Top Ten Leading Private Enterprises with Independent Innovation Capabilities, China Contract-Fulfilling and Trustworthy Enterprise, National Advanced Private Enterprise for Employment and Social Security, and China Charity Award.

In the future, CHINT will march towards the targets of creating world famous brands and contributing to an industrial power. It will focus on building the Energy Internet and becoming a smart energy developer and operator. The group will make great efforts to implement three policies: globalization, M&A and integration, and smart manufacturing. Four platforms will be created, including scientific innovation and industrial incubation platform, online industrial and civil Internet of Things platform, online & offline supply chain interaction platform, and investment & financing and payment platform. Four industrial clusters will also be developed, including smart electrical system solution industrial cluster for smart grid, industrial automation information cluster for smart cities, clean energy, environment protection, and energy conservation industrial cluster for smart micro-grid, high-tech material information technology and high-end equipment industrial cluster for smart manufacturing, and Internet of Things IT and smart home industrial group for smart business.



The Next Reliable Choice

Motor Control & Protection



The solution for various voltage fluctuation, guarantee the steady operation of the system

With 70% - 120% pull-in voltage range, which can avoid the voltage fluctuation in grid, also operates steadily in the peak power demands.



Equipped with more standard auxiliary contacts, to meet several application requirements

Standard equipped with 1NO+1NC below 100A and 2NO+2NC above 100A, which can optimize the inventory and cost performance.



Ergonomically design, easy to handle and maintain

Integrated label cover, with double coil terminal blocks, which can fast be connected without tools.



Delicate current specification, more cost-effective performance

Newly increase 6A, 16A, 22A, 38A, 75A, which fully cover 6-630A.



Absolute adaptability, with steady and reliable operation in extreme conditions

-35°C/+70°C operating temperature range. Meets several applications requirements.

70%~120% pull-in voltage

Against voltage fluctuation
More steady and
reliable performance



Content

NXC AC contactor

Overview	P-01
Description	P-02
Parameters	P-04
Accessories	P-07
Dimensions and installation	P-11
Wiring diagrams	P-13
Annex I: Instructions for use in abnormal conditions	P-15
Annex II: Utilization category description	P-16

NXR thermal overload relay

Overview	P-17
Description	P-18
Parameters	P-20
Product front view	P-21
Dimensions and installation	P-21
Wiring diagrams	P-26
Annex I: Instructions for use in abnormal conditions	P-26

NXJ plug-in relay

Overview	P-27
Description	P-27
Parameters	P-27
Accessories	P-29
Dimensions and installation	P-29

NXC AC contactor



Overview

Applicable scope

The new NXC AC contactors feature a novel appearance and a compact structure. They are mainly used for frequent starts and control of AC motors as well as remote circuit making /breaking. They can also be combined with appropriate thermal overload relays to form electromagnetic starters.

Compliant standards: IEC 60947-1, IEC 60947-4-1, IEC 60947-5-1.

Parameters

- Rated operation current Ie: 6A~630A
- Rated operation voltage Ue: 220V~690V
- Rated insulation voltage: 690V (NXC-06M~100), 1000V (NXC-120~630)
- Number of poles: 3P and 4P (only for NXC-06M~12M)
- Coil control method: AC (NXC-06(M)~225), DC (NXC-06M~12M), AC/DC (NXC-265~630)
- Installation method: NXC-06M~100 rail and screw installation, NXC-120~630 screw installation

Operation and installation conditions

Type	Operation and installation conditions
Installation class	III
Pollution degree	3
Compliant standards	IEC 60947-1, IEC 60947-4-1, IEC 60947-5-1
Certification mark	CE
Enclosure protection degree	NXC-06M~38: IP20; NXC-40~100: IP10; NXC-120~630: IP00
Ambient temperature	Operation temperature limits: -35°C~+70°C. Normal operation temperature range: -5°C~+40°C. The 24-hour average temperature should not exceed +35°C. For use beyond the normal operation temperature range, see "Instructions for use in abnormal conditions" in the annex.
Altitude	Not exceeding 2000 m above sea level
Atmospheric conditions	The relative humidity should not exceed 50% at the upper temperature limit of +70°C. A higher relative humidity is allowed at a lower temperature, e.g. 90% at +20°C. Special precautions should be taken against occasional condensation due to humidity variations.
Installation conditions	The angle between the installation surface and the vertical surface should not exceed ±5°.
Shock and vibration	The product should be installed in places without significant shaking, shock, and vibration.

Description

NXC AC contactor				
NXC	12	/N	230V	50Hz
Model	Rated current	Special function	Coil voltage	Frequency
	06, 09, 12, 16, 18, 22, 25, 32, 38, 40, 50, 65, 75, 85, 100, 120, 160, 185, 225, 265, 330, 400, 500, 630	/N: Reversible contactor	24V, 36V, 48V, 110V, 127V, 220V, 380V, 415V, 440V, 480V, 660V (AC: 06A~225A; AC/DC: 265A~630A)	50Hz, 60Hz, 50/60Hz

Note: 06A-100A products contain one NO auxiliary contact and one NC auxiliary contact. 120A-630A products contain two NO auxiliary contacts and two NC auxiliary contacts.

NXC miniature 3P AC contactor						
NXC	06M	10	/Z	/N	230V	50Hz
Model	Rated current	Auxiliary contact	Coil form	Special function	Coil voltage	Frequency
	06M 09M 12M	10: NO 01: NC	/Z: DC control coil	/N: Reversible contactor	AC: 24V, 36V, 48V, 110V, 127V, 220V, 380V, 415V, 440V, 480V, 660V DC: 24V, 48V, 110V, 220V	50Hz, 60Hz, 50/60Hz

NXC miniature 4P AC contactor						
NXC	06M	/22	/Z	/N	230V	50Hz
Model	Rated current	4P main contact combination	Coil form	Special function	Coil voltage	Frequency
	06M 09M 12M	/22: 2 NO and 2 NC main contacts /04: 4 NC main contacts /40: 4 NO main contacts	/Z: DC control coil	/N: Reversible contactor	AC: 24V, 36V, 48V, 110V, 127V, 220V, 380V, 415V, 440V, 480V, 660V DC: 24V, 48V, 110V, 220V	50Hz, 60Hz, 50/60Hz

Model example: NXC-12 230V 50Hz represents an AC contactor under AC-3 utilization category that provides a rated current of 12A at a main circuit voltage of 380V/400V. Each contactor body contains one NO auxiliary contact and one NC auxiliary contact. The coil control voltage and frequency are 220V AC and 50Hz respectively.

NXC AC contactor

NXC AC contactor selection table

Motor power kW			Maximum operation current A (AC-3 380V/400V)	Number of contacts contained in the contactor body		Contactor model
220V/230V/240V	380V/400V	660V/690V		NO	NC	
1.5	2.2	3	6	1	0	NXC-06M10
1.5	2.2	3	6	0	1	NXC-06M01
1.5	2.2	3	6	1	1	NXC-06
2.2	4	4	9	1	0	NXC-09M10
2.2	4	4	9	0	1	NXC-09M01
2.2	4	5.5	9	1	1	NXC-09
3	5.5	4	12	1	0	NXC-12M10
3	5.5	4	12	0	1	NXC-12M01
3	5.5	7.5	12	1	1	NXC-12
3	7.5	7.5	16	1	1	NXC-16
4	7.5	10	18	1	1	NXC-18
5.5	11	11	22	1	1	NXC-22
5.5	11	15	25	1	1	NXC-25
7.5	15	18.5	32	1	1	NXC-32
9	18.5	18.5	38	1	1	NXC-38
11	18.5	30	40	1	1	NXC-40
15	22	37	50	1	1	NXC-50
18.5	30	37	65	1	1	NXC-65
22	37	37	75	1	1	NXC-75
22	37	45	85	1	1	NXC-85
25	45	45	100	1	1	NXC-100
37	55	80	120	2	2	NXC-120
45	75	100	160	2	2	NXC-160
55	90	100	185	2	2	NXC-185
63	110	110	225	2	2	NXC-225
75	132	160	265	2	2	NXC-265
90	160	200	330	2	2	NXC-330
132	200	300	400	2	2	NXC-400
160	250	335	500	2	2	NXC-500
200	335	350	630	2	2	NXC-630

Coil voltage specification table

NXC-06M~12M

AC (V) 50Hz	24	36	48	110	127	220	380	415
AC (V) 60Hz	24	36	48	110	127	220	380	415
DC (V)	24	-	48	110	-	220	-	-

NXC-06~100

AC (V) 50Hz	24	36	48	110	127	220	380	415
AC (V) 60Hz	24	36	48	110	127	220	380	415

NXC-120~225



AC (V) 50Hz	-	-	-	-	110	127	220	380
AC (V) 60Hz	-	-	-	-	110	127	220	380

NXC-265~630

AC/DC (V)	-	-	-	-	110~127	220~240	380~415	-
-----------	---	---	---	---	---------	---------	---------	---

Parameters



Main circuit parameters and technical performance

Contactor model		NXC-06M	NXC-09M	NXC-12M	NXC-06	NXC-09	NXC-12	NXC-16	NXC-18	NXC-22	
											
Conventional thermal current Ith (A)		20	20	20	20	20	25	25	32	32	
Rated insulation voltage Ui (V)		690									
Rated impulse withstand voltage Uimp (kV)		6			8						
Rated making capacity		Making current: 10xIe (AC-3) or 12xIe (AC-4)									
Rated breaking capacity		Breaking current: 8xIe (AC-3) or 10xIe (AC-4)									
Rated operation current Ie (A)	220V/230V	AC-3	6	9	12	6	9	12	16	18	22
		AC-4	6	9	12	6	9	12	16	18	22
	380V/400V	AC-3	6	9	12	6	9	12	16	18	22
		AC-4	6	9	9	6	9	12	12	18	18
	660V/690V	AC-3	3.8	4.9	4.9	3.8	6.6	8.9	8.9	12	14
		AC-4	3.8	4.9	4.9	3.8	6.6	8.9	8.9	12	12
Rated control power (kW)	AC-3	220V/230V	1.5	2.2	3	1.5	2.2	3	3	4	5.5
		380V/400V	2.2	4	5.5	2.2	4	5.5	7.5	7.5	11
		660V/690V	3	4	4	3	5.5	7.5	7.5	10	11
Electrical life (cycles)		AC-3	1.2x10 ⁶								
Mechanical life (cycles)		1.2x10 ⁷									
Main contact		3 NO, 4 NO, 2 NO+2 NC			3 NO						
Fuse supplied for SCPD		NT00-20	NT00-20	NT00-25	NT00-20	NT00-20	NT00-25	NT00-25	NT00-32	NT00-32	
Matching thermal overload relay		Model	NXR-12			NXR-25					
Built-in auxiliary contact		3P	1 NO or 1 NC			1 NO+1 NC					
		4P	-								

Control circuit		Contactor model	NXC-06M	NXC-09M	NXC-12M	NXC-06	NXC-09	NXC-12	NXC-16	NXC-18	NXC-22
Main circuit connection	Cable connection (mm ²)	Prefabricated flexible wire	1	1~2.5			1~4		1.5~6		
			2	1~1.5			1~2.5		1.5~4		
		Hard wire	1	1~2.5			1~4		1.5~6		
			2	1~2.5			1~4		1.5~6		
	Size of fastening screw		M3			M3.5		M3.5			
Tightening torque (N·m)		0.8			0.8		0.8				
Control circuit connection	Cable connection (mm ²)	Prefabricated flexible wire	1	1~2.5			1~4				
			2	1~1.5			1~2.5				
		Hard wire	1	1~2.5			1~4				
			2	1~2.5			1~4				
	Size of fastening screw		M3			M3.5					
Tightening torque (N·m)		0.8			0.8						

Contactor model		NXC-06M	NXC-09M	NXC-12M	NXC-06	NXC-09	NXC-12	NXC-16	NXC-18	NXC-22
Coil control power supply	AC 50Hz	24, 36, 48, 110, 127, 220, 380, 415			24, 36, 48, 110, 127, 220, 380, 415					
	DC	24, 48, 110, 220			-					
Control voltage	Pull-in	(75%~120%) Us			(70%~120%) Us					
	Release	AC: (20%~70%) Us; DC: (10%~70%) Us			(20%~65%) Us					
Coil average power (VA)	Start	25~40			40~60					40~60
	Hold	2~7			9.5					9.5
Heat dissipation (W)	AC	1~3			1~3					1~3
	DC	-			-					-

NXC AC contactor

Contactor model		NXC-25	NXC-32	NXC-38	NXC-40	NXC-50	NXC-65	NXC-75	NXC-85	NXC-100		
												
Conventional thermal current I _{th} (A)		40	50	50	60	80	80	90	100	110		
Rated insulation voltage U _i (V)		690										
Rated impulse withstand voltage U _{imp} (kV)		8										
Rated making capacity		Making current: 10xI _e (AC-3) or 12xI _e (AC-4)										
Rated breaking capacity		Breaking current: 8xI _e (AC-3) or 10xI _e (AC-4)										
Rated operation current I _e (A)	220V/230V	AC-3	25	32	38	40	50	65	75	85	100	
		AC-4	25	32	38	40	50	65	75	85	100	
	380V/400V	AC-3	25	32	38	40	50	65	75	85	100	
		AC-4	25	32	32	40	50	65	75	85	100	
	660V/690V	AC-3	18	22	22	34	39	42	42	49	49	
		AC-4	18	22	22	34	39	42	42	49	49	
Rated control power (kW)	AC-3 (kW)	220V/230V	5.5	7.5	9	11	15	18.5	22	22	25	
		380V/400V	11	15	18.5	18.5	22	30	37	37	45	
		660V/690V	15	18.5	18.5	30	37	37	37	45	45	
Electrical life (cycles)	AC-3	1.2x10 ⁶			1x10 ⁶			0.8x10 ⁶				
	AC-4	See electrical life curve										
Mechanical life (cycles)		1x10 ⁷				0.9x10 ⁷			0.65x10 ⁷			
Main contact		3 NO										
Fuse supplied for SCPD		gG50	gG63	gG63	gG63	gG80	gG80	gG100	gG100	gG125		
Matching thermal overload relay		Model	NXR-25	NXR-38		NXR-100						
Built-in auxiliary contact		3P	1 NO+1 NC									
		4P	-									

Control circuit		Contactor model	NXC-25	NXC-32	NXC-38	NXC-40	NXC-50	NXC-65	NXC-75	NXC-85	NXC-100	
Main circuit connection	Cabling (mm ²)	Prefabricated flexible wire	1	1.5~10			6~25		10~35			
			2	1.5~6			4~10		6~16			
		Hard wire	1	1.5~6			6~25		10~35			
			2	1.5~6			4~10		6~16			
	Size of fastening screw			M4			M8		M8			
	Tightening torque (N·m)			1.2			6		6			
Control circuit connection	Cabling (mm ²)	Prefabricated flexible wire	1	1~4								
			2	1~2.5								
		Hard wire	1	1~4								
			2	1~4								
	Size of fastening screw			M3.5								
	Tightening torque (N·m)			0.8								

Contactor model		NXC-25	NXC-32	NXC-38	NXC-40	NXC-50	NXC-65	NXC-75	NXC-85	NXC-100	
Coil control power supply	AC 50Hz	24, 36, 48, 110, 127, 220, 380, 415									
Control voltage	Pull-in	(70%~120%) U _s									
	Release	(20%~65%) U _s									
Coil average power (VA)	Start	50~70			160~210			190~250			
	Hold	8~11.4			13~25			17~30			
Heat dissipation (W)	AC	1~3			4~8			6~10			
	DC	-			-			-			

NXC AC contactor

Contactor model		NXC-120	NXC-160	NXC-185	NXC-225	NXC-265	NXC-330	NXC-400	NXC-500	NXC-630	
											
Conventional thermal current Ith (A)		200	200	275	275	315	380	450	630	700	
Rated insulation voltage Ui (V)		1000									
Rated impulse withstand voltage Uimp (kV)		12									
Rated making capacity		Making current: 10xle (AC-3) or 12xle (AC-4)									
Rated breaking capacity		Breaking current: 8xle (AC-3) or 10xle (AC-4)									
Rated operation current Ie (A)	220V/230V	AC-3	120	160	185	225	265	330	400	500	630
		AC-4	120	160	160	185	265	330	330	500	500
	380V/400V	AC-3	120	160	185	225	265	330	400	500	630
		AC-4	120	160	160	185	265	330	330	500	500
	660V/690V	AC-3	86	107	107	118	170	235	303	353	400
		AC-4	86	107	107	107	137	170	235	303	353
Rated control power (kW)	AC-3 (kW)	220V/230V	37	45	55	63	75	90	132	160	200
		380V/400V	55	75	90	110	132	160	200	250	335
		660V/690V	80	100	100	110	160	200	300	335	350
Electrical life (cycles)		AC-3	1.2x10 ⁶			0.8x10 ⁶					
		AC-4	See electrical life curve								
Mechanical life (cycles)		0.6x10 ⁷									
Main contact		3 NO									
Fuse supplied for SCPD		gG224	gG224	gG315	gG315	gG400	gG425	gG500	gG800	gG950	
Matching thermal overload relay		Model	NXR-200			NXR-630					
Built-in auxiliary contact		3P	2 NO+2 NC								
		4P	-								

Control circuit		Contactor model	NXC-120	NXC-160	NXC-185	NXC-225	NXC-265	NXC-330	NXC-400	NXC-500	NXC-630	
Main circuit connection	Cable connection (mm ²)	Prefabricated flexible wire	1	10~150								
			2	10~75								
		Hard wire	1	10~150			50~240					
			2	10~75			50~240					
	Size of fastening screw			M6	M8	M10						
Tightening torque (N·m)			10			14						
Control circuit connection	Cable connection (mm ²)	Prefabricated flexible wire	1	1~4								
			2	1~2.5								
		Hard wire	1	1~4								
			2	1~4								
	Size of fastening screw			M3.5								
Tightening torque (N·m)			0.8									

Contactor model		NXC-120	NXC-160	NXC-185	NXC-225	NXC-265	NXC-330	NXC-400	NXC-500	NXC-630	
Coil control power supply	AC 50Hz	110, 127, 220, 380				Common for AC and DC: 110, 127, 220, 380					
	DC	-									
Control voltage	Pull-in	(75%~120%)Us				(75%~120%)Us					
	Release	(20%~70%)Us				(10%~70%)Us					
Coil average power (VA)	Start	500				600			800		
	Hold	50				11			11		
Heat dissipation (W)	AC	30~50				3~6			3~7		
	DC	-				3~6			3~7		

NXC AC contactor

Accessories

Accessory diagrams

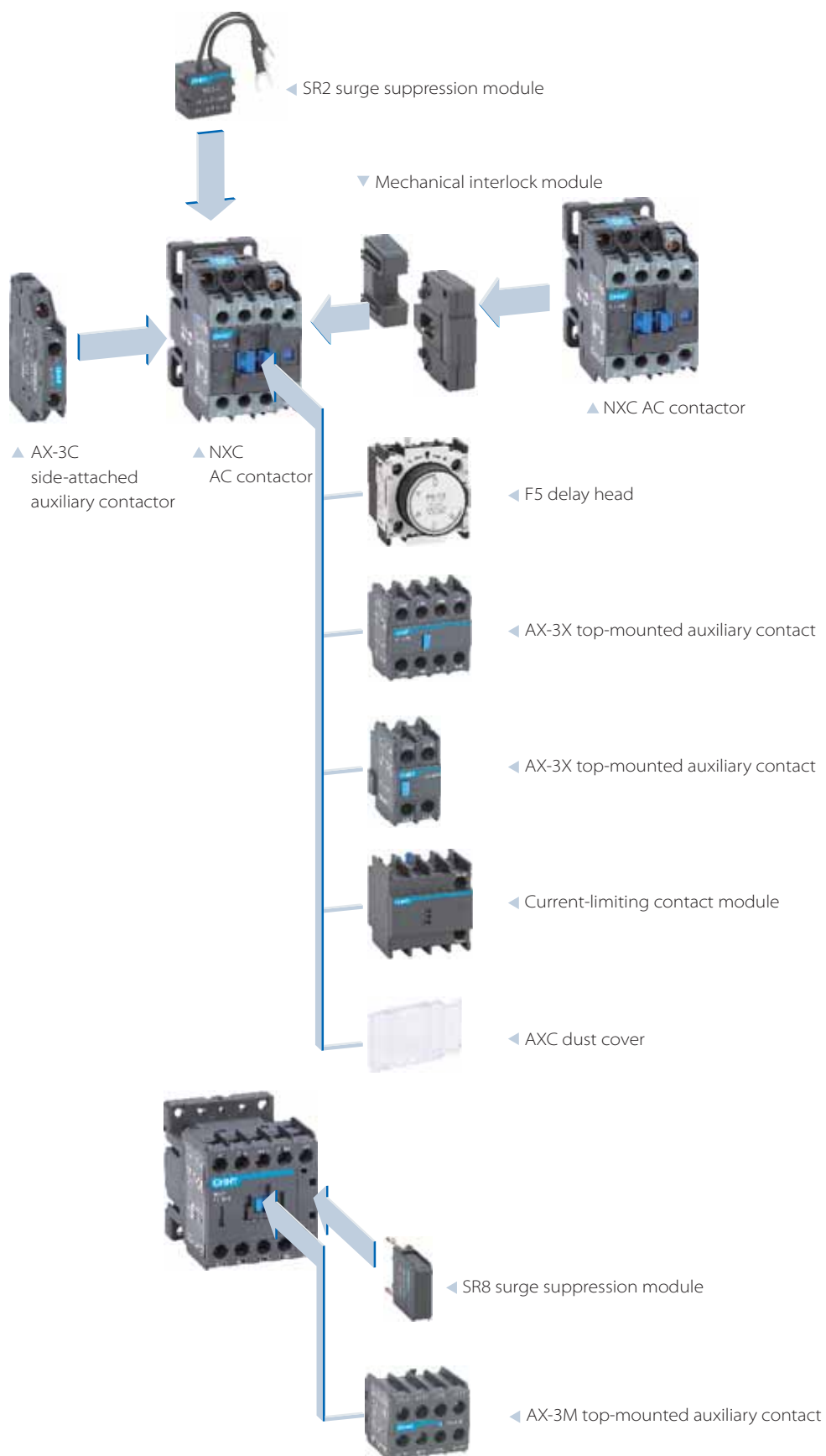

Accessory description

Top-mounted auxiliary contact group

AX - 3X	/	11	AX - 3M	/	11
Auxiliary contact group model		NO and NC auxiliary contact pair combination	Auxiliary contact group model		NO and NC auxiliary contact pair combination
Applicable to 6A-630A AC contactor product		11, 20, 02 22, 13, 31 04, 40	Applicable to NXC-06M ~12M AC contactor product		11, 20, 02 22, 13, 31 04, 40

Side-attached auxiliary contact group

AX - 3C	/	11	B
Side-attached auxiliary contact group model		NO and NC contact pair combination	A: Standard model, left omitted, applicable to 6A~225A AC contactor
		11	B: Expanded model, used for 265A~630A AC contactor

Dust cover

AXC	-	1
Dust cover		1: Used for NXC-06~22, NXC-120~630 2: Used for NXC-25~38 3: Used for NXC-40~65 4: Used for NXC-75~100

Air delay head

F5	/	T	4
Air delay head model		Delay type	Delay range
		T: Power-on delay D: Power-off delay	0: 0.1~3s 2: 0.1~30s 4: 10~180s

NXC AC contactor

Accessory selection table (auxiliary contact)

Contactor	Optional accessory	Accessory model	Contact combination
NXC-06M~12M	AX-3M top-mounted auxiliary contact	AX-3M/20	2NO+0NC
		AX-3M/11	1NO+1NC
		AX-3M/02	0NO+2NC
		AX-3M/40	4NO+0NC
		AX-3M/31	3NO+1NC
		AX-3M/22	2NO+2NC
		AX-3M/13	1NO+3NC
NXC-06~225	AX-3X top-mounted auxiliary contact	AX-3X/20	2NO+0NC
		AX-3X/11	1NO+1NC
		AX-3X/02	0NO+2NC
		AX-3X/40	4NO+0NC
		AX-3X/31	3NO+1NC
		AX-3X/22	2NO+2NC
		AX-3X/13	1NO+3NC
	AX-3X/04	0NO+4NC	
	AX-3C side-attached auxiliary contact	AX-3C/11	1NO+1NC
NXC-265~630	AX-3X top-mounted auxiliary contact	AX-3X/20	2NO+0NC
		AX-3X/11	1NO+1NC
		AX-3X/02	0NO+2NC
		AX-3X/40	4NO+0NC
		AX-3X/31	3NO+1NC
		AX-3X/22	2NO+2NC
		AX-3X/13	1NO+3NC
	AX-3X/04	0NO+4NC	
		AX-3C side-attached auxiliary contact	AX-3C/11B

Accessory selection table (air delay head)

Contactor	Optional accessory	Accessory model	Contact combination	Delay range (s)
NXC full series (except for NXC-06M~12M)	F5 air delay head	F5-T0	1NO+1NC	0.1~3
		F5-T2	1NO+1NC	0.1~30
		F5-T4	1NO+1NC	10~180
		F5-D0	1NO+1NC	0.1~3
		F5-D2	1NO+1NC	0.1~30
		F5-D4	1NO+1NC	10~180

Accessory selection table (dust cover)

Contactor	Optional accessory
NXC-06~22, NXC-120~630	AXC-1 dust cover
NXC-25~38	AXC-2 dust cover
NXC-40~65	AXC-3 dust cover
NXC-75~100	AXC-4 dust cover

Main parameters and technical performance indicators of accessories

Item		Main technical parameters		
Rated operation current (V)		To 690		
Rated insulation voltage (V)		690		
Conventional thermal current I _{th} (A)		10		
Rated making capacity (A)		Breaking current 10 I _e (AC-15) or I _e (DC-13)		
Short-circuit protection		gG fuse: 10A		
Control capacity	Auxiliary contact	AC-15	380V/400V	1.5A
		DC-13	220V	0.3A
	F5 air delay head	AC-15	660V/380V	0.52A/0.95A
		DC-13	220V	0.15A
Compliant standards		IEC/EN 60947-5-1		
Product certification		CE		
Enclosure protection degree		IP 20		
Cable connection (mm ²)	Flexible wire without cold-pressed terminal	1~4		
		1~4		
	Flexible wire with cold-pressed terminal	1~4		
		1~2.5		
	Hard wire	1~4		
		1~4		
Fastening screw size		M3.5, M3 (AX-3M)		
Tightening torque (N·m)		0.8		

Derivative products

Name	Reversible AC contactor
Reversible AC contactor	

NXC AC contactor

Dimensions and installation

NXC-06M-12M

Dimensions and installation

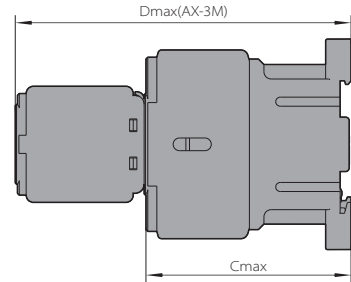
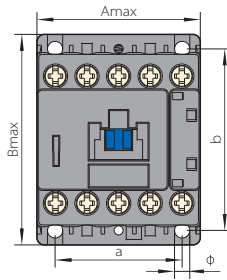

Model	Amax	Bmax	Cmax	Dmax	a	b	Φ
NXC-06M-12M	45.5	59	58	94	35±0.35	50±0.48	4.2
NXC-06M/4-12M/4	45.5	59	58	94	35±0.35	50±0.48	4.2
NXC-06M/Z-12M/Z	45.5	59	70	106	35±0.35	50±0.48	4.2
NXC-06M/4/Z-12M/4/Z	45.5	59	70	106	35±0.35	50±0.48	4.2

NXC-06-22

Dimensions and installation

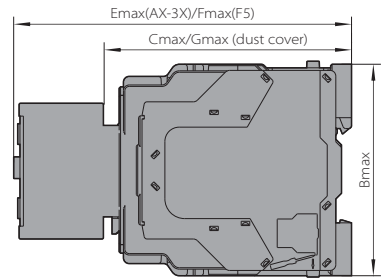
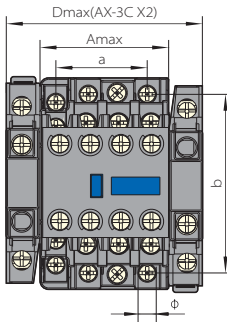

NXC-25-100

Dimensions and installation

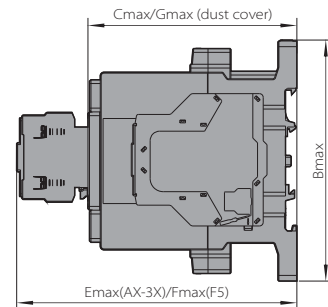
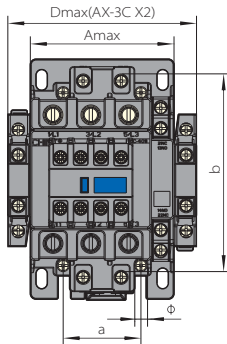

Model	Amax	Bmax	Cmax	Dmax	Emax	Fmax	Gmax	a	b	Φ
NXC-06-22	45.5	75	88	70	126.5	146.5	90	35±0.31	62±0.31	4.5
NXC-25-38	56.5	87	93	81	131.5	151.5	95	40±0.31	48±0.31	4.5
NXC-40-65	77	129	118	102	156.5	176.5	121	40±0.31	105±0.31	4.4
NXC-75-100	87	132	127	112	165.5	185.5	129	40±0.28	105±0.57	6.5

NXC-120-225

Dimensions and installation

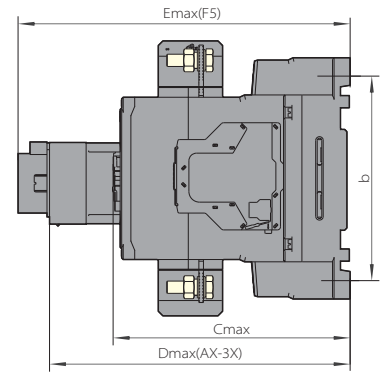
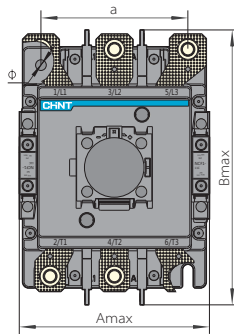

NXC-265-400

Dimensions and installation

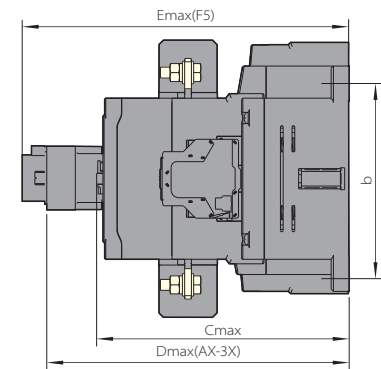
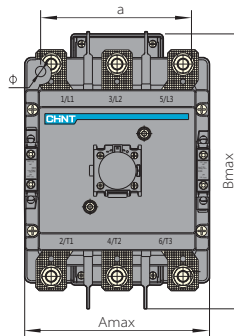

NXC-500-630

Dimensions and installation

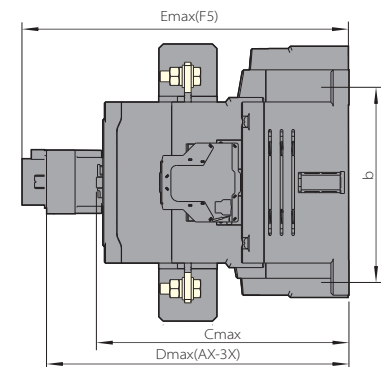
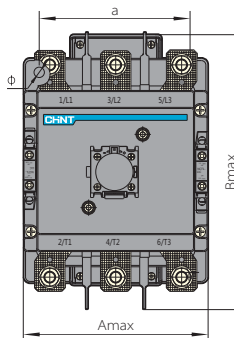

Model	Amax	Bmax	Cmax	Dmax	Emax	a	b	Φ
NXC-120-225	127	182	158	196.5	216.5	96±0.5	133.6±0.8	7
NXC-265-400	150	236	207	245.5	265.5	120±0.5	180±0.8	9
NXC-500-630	165	248	225	263.5	283.5	130±0.5	180±0.8	9

NXC AC contactor

Wiring diagrams

NXC-06~100

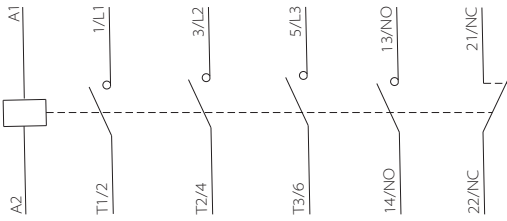

NXC-120~630

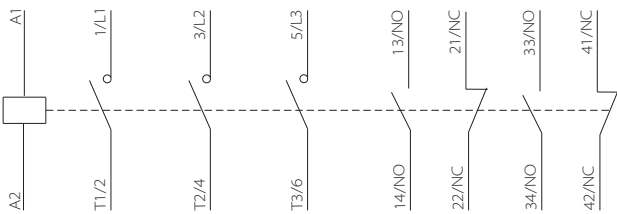

AX-3X/11

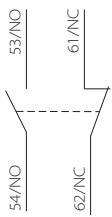

AX-3X/20

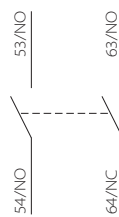

AX-3X/02

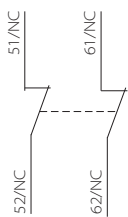

AX-3X/22

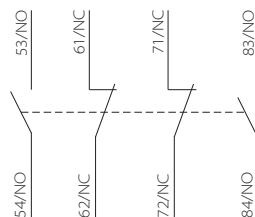

AX-3X/13

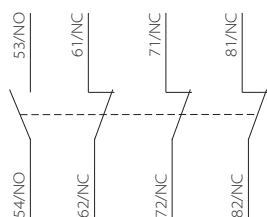

AX-3X/40

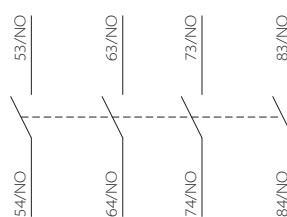

AX-3X/04

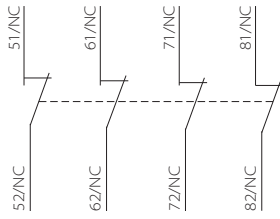

AX-3X/31

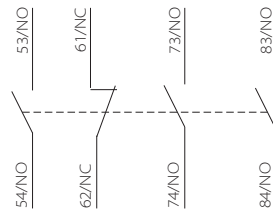

AX-3M/11

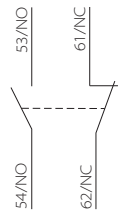

AX-3M/20

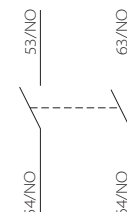

AX-3M/02

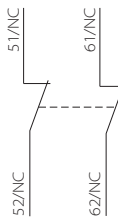

AX-3M/22

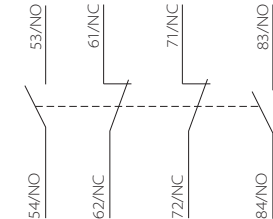

AX-3M/13

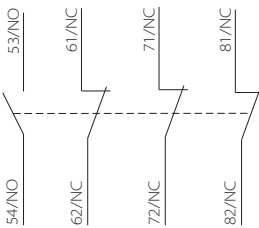

AX-3M/40

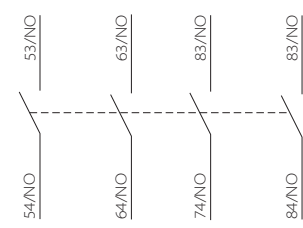

AX-3M/04

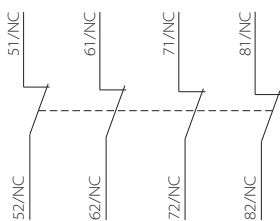

AX-3M/31

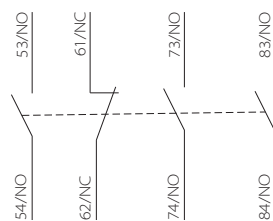

NXC AC contactor

Annex I: Instructions for use in abnormal conditions

Instructions for use of correction factors in high altitude areas

- IEC 60947-1 standard defines the relation between altitude and impulse withstand voltage. An altitude of 2000 m above sea level or lower has no significant impact on product performance.
- At an altitude higher than 2000 m, air cooling effect and decrease of rated impulse withstand voltage have to be considered. In this case, design and use of products have to be negotiated by the manufacturer and the user.
- The correction factors for rated impulse withstand voltage and rated operation current for altitudes higher than 2000 m are given in the following table. The rated operation voltage remains unchanged.

Altitude (m)	2000	3000	4000
Rated impulse withstand voltage correction factor	1	0.88	0.78
Rated operation current correction factor	1	0.92	0.9

Instructions for use under abnormal ambient temperature

- IEC 60947-1 standard defines normal operation temperature range for products. Use of products in the normal range will not cause significant impact on their performance.
- At an operation temperature higher than +40°C, the tolerable temperature rise of products needs to be reduced. Both rated operation current and number of contactors in standard products have to be decreased to prevent product damage, shortened service life, lower reliability, or impact on control voltage. At a temperature lower than -5°C, freezing of insulation and lubrication grease should be considered to prevent action failures. In these cases, design and use of products have to be negotiated by the manufacturer and the user.
- The correction factors for different rated operation current under operation temperature higher than +55°C are given in the following table. The rated operation voltage remains unchanged.

Ambient temperature (°C)	55	60	65	70
Correction factor	1	0.93	0.875	0.75

- At the temperature range of +55°C~+70°C, the pull-in voltage range of AC contactors is (90%~110%)Us, and (70%~120%)Us is the results of cold status tests at 40°C ambient temperature.

Instructions for derating during use in corrosive environment

- Impact on metal parts
 Chlorine Cl₂, nitrogen dioxide NO₂, hydrogen sulfide H₂S, sulfur dioxide SO₂
 Copper: The thickness of copper sulfide coating in chlorine environment will be twice that in normal environment conditions. This is also the case for environments with nitrogen dioxide.
 Silver: When used in SO₂ or H₂S environment, the surface of silver or silver coated contacts will become dark due to formation of a silver sulfide coating. This will lead to higher contact temperature rise and may damage to the contacts.
 In humid environments where Cl₂ and H₂S coexist, the coating thickness will increase by 7 times. With presence of both H₂S and NO₂, the silver sulfide thickness will increase by 20 times.
- Considerations during product selection
 In refinery, steel, paper, artificial fiber (nylon) industry or other industries using sulphur, equipment may experience vulcanization (also called oxidization in some industrial sectors). Equipment installed in machine rooms is not always well protected from oxidization. Short inlets are often used to ensure that the pressure in such rooms is slightly higher than atmospheric pressure, which helps reduce pollutions due to external factor to a certain degree. However, after operation for 5 to 6 years, the equipment still experience rust and oxidization inevitably. Hence in operation environments with corrosive gas, the equipment needs to be used with derating. The derating coefficient relative to the rated value is 0.6 (up to 0.8). This helps reduce rate of accelerated oxidization due to temperature rise.

Instructions for use with parallel poles

- In case of parallel poles, the rated current of such poles needs to be corrected to make up for distribution of long-term unstable current, as shown in the table below:

Number of parallel poles	2	3	4
Correction factor	1.6	2.25	2.8

Annex II: Utilization category description

Different types of power-consuming equipment may have significantly different loading characteristics and current changes during making/breaking, hence they have different requirements for contactors. IEC 60947-1 standard defines contactor utilization categories that are indicated by one or more of the following use conditions:

- Current, indicated with multiples of rated current
- Voltage, indicated with multiples of rated voltage
- Power factor or time constant
- Short-circuit performance
- Selectivity
- Other use conditions (if applicable)

NXC AC contactors mainly include the following categories:

Utilization categories of AC main circuit

AC-1 type

This type is used for AC loads with a power factor higher than or equal to 0.95.

Examples: heating, power distribution.

AC-2 type

This type is used for start reverse braking and inching of slip ring motors.

During closing, the contactor makes a start current that is about 2.5 times motor rated current.

During opening, the contactor must break the start current at a voltage lower than or equal to the main supply voltage.

AC-3 type

This type is used for breaking normally started squirrel cage motors.

During closing, the contactor makes a start current that is about 7 times motor rated current.

During opening, the contactor breaks motor rated current. In this case, the voltage at the contactor wire terminal is about 20% of main supply voltage. The breaking process is not harsh.

Examples: all standard squirrel cage motors such as those in elevator, escalator, conveyance belt, air compressor, pump, mixer, and air conditioner.

AC-4 type

This type is used for reverse braking and inching of squirrel motors and slip ring motors.

The contactor makes a current that is 5 to 7 times rated motor current, and breaks the same current at higher voltage. At lower motor RPMs, the voltage breaking is as harsh as main voltage.

Control circuit utilization categories.

Examples: printing machinery, wire drawing machine, tower crane, crane, metallurgy

DC-13 type

This type of system is used for starting, reverse current braking, and inching of DC shunt excited machines. The duration is equal to or less than 2 ms.

This type is used for switching electromagnetic loads.

AC-15 type

This type is used for switching electromagnetic loads. The pull-in power during closing of electromagnet is higher than 72VA.

Examples: operation coil of switch contactors.

NXR thermal overload relay



Overview

Applicable scope

NXR thermal overload relays (hereinafter abbreviated as thermal relays) are suitable for overload and phase loss protection for uninterrupted or intermittent AC motors with AC frequency of 50 Hz/60 Hz, a voltage up to 690 V, and a current of (0.1-630)A.

The thermal relays also provide temperature compensation, action indication, automatic and manual reset, stop, and testing functions. The products are characterized by stable and reliable performance. The thermal relays can be plugged into contactors or installed independently.

Compliant standards: IEC 60947-4-1, IEC 60947-5-1.

Structural characteristics

- Three-phase bi-metal sheet type or electronic type (NXR-200, NXR-630), with a tripping level of 10A
- With phase loss protection
- With a device for continuous adjustment of setting current
- With temperature compensation
- With action indication
- With testing mechanism
- With stop bottom
- With manual and automatic reset button (NXR-200 and NXR-630 only have manual reset)
- With one NO contact and one NC contact that are electrically separable
- Installation method: Plugged into contactor (NXR-12, 25, 38, 100) or installed independently (NXR-200, 630)
- Protection characteristics

Operation environment

Type	Operation and installation conditions
Installation type	III
Pollution degree	3
Compliant standards	IEC 60947-4-1, IEC 60947-5-1
Certification mark	CE
Enclosure protection degree	IP20 (NXR-12, 25, 38, 100)
Ambient temperature	Operation temperature limits: -35°C~+70°C. Normal operation temperature range: -5°C~+40°C. The 24-hour average temperature should not exceed +35°C. For use beyond the normal operation temperature range, see "Instructions for use in abnormal conditions" in the annex.
Altitude	Not exceeding 2000m above sea level
Atmospheric conditions	The relative humidity should not exceed 50% at the upper temperature limit of +70°C. A higher relative humidity is allowed at a lower temperature, e.g. 90% at +20°C. Special precautions should be taken against occasional condensation due to humidity variations.
Installation conditions	The angle between the installation surface and the vertical surface should not exceed ±5°.
Shock and vibration	The product should be installed in places without significant shaking, shock, and vibration.

Description

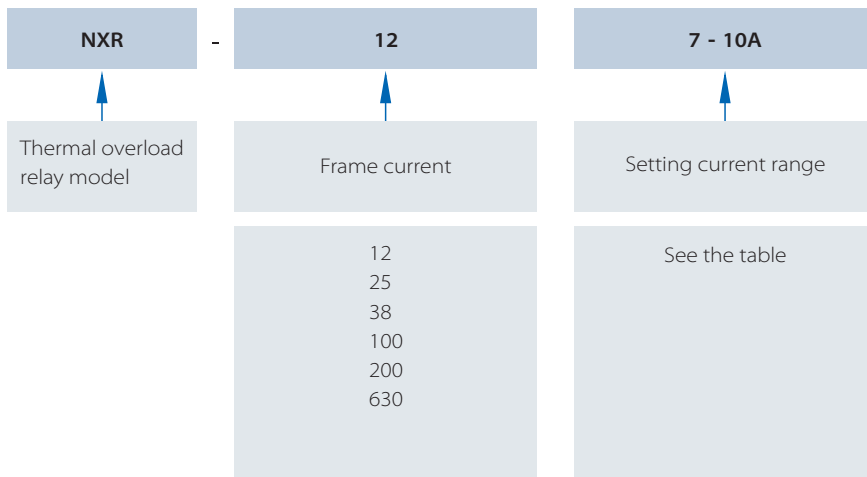

Frame	Setting current
12	0.1-0.16A
	0.16-0.25A
	0.25-0.4A
	0.4-0.63A
	0.63-1A
	1-1.6A
	1.25-2A
	1.6-2.5A
	2.5-4A
	4-6A
	5.5-8A
	7-10A
9-12A	

Frame	Setting current
25	0.1-0.16A
	0.16-0.25A
	0.25-0.4A
	0.4-0.63A
	0.63-1A
	1-1.6A
	1.25-2A
	1.6-2.5A
	2.5-4A
	4-6A
	5.5-8A
	7-10A
9-13A	
12-18A	
17-25A	

Frame	Setting current
38	23-32A
	30-38A
100	23-32A
	30-40A
	37-50A
	48-65A
	55-70A
200	63-80A
	80-93A
	80-100A
630	80-160A
	100-200A
	125-250A
	200-400A
	315-630A

Selection example:

"NXR-25 7-10A" represents a NXR 3P thermal overload relay with a frame current class of 25 and a setting current range between 7A and 10A.

NXR thermal overload relay

Quick selection and matching table

Product appearance	Rated current A	Specification of matching fuse (RT16 recommended) A	Model of matching contactor
		gG	
 NXR-12	0.1~0.16	2	 NXC-06M, 09M, 12M
	0.16~0.25	2	
	0.25~0.4	2	
	0.4~0.63	2	
	0.63~1	4	
	1~1.6	4	
	1.25~2	6	
	1.6~2.5	6	
	2.5~4	10	
	4~6	16	
	5.5~8	20	
	7~10	20	
9~12	25		
 NXR-25	0.1~0.16	2	 NXC-06, 09, 12, 16, 18, 22, 25, 32, 38
	0.16~0.25	2	
	0.25~0.4	2	
	0.4~0.63	2	
	0.63~1	4	
	1~1.6	4	
	1.25~2	6	
	1.6~2.5	6	
	2.5~4	10	
	4~6	16	
	5.5~8	20	
	7~10	20	
9~13	25		
12~18	35		
17~25	50		
 NXR-38	23~32	63	 NXC-25, 32, 38
	30~38	80	
 NXR-100	23~32	63	 NXC-40, 50, 65, 75, 85, 100
	30~40	100	
	37~50	100	
	48~65	100	
	55~70	125	
	63~80	125	
	80~93	160	
80~100	160		
 NXR-200	80~160	315	 NXC-120, 160, 185, 225
	125~200	315	
 NXR-630	125~250	800	 NXC-225, 265, 330, 400, 500, 630
	200~400	800	
	315~630	800	

NXR thermal overload relay

Parameters

Item		NXR-12	NXR-25	NXR-38	NXR-100	NXR-200	NXR-630	
Current level		12	25	38	100	200	630	
Rated insulation voltage V		690	690	690	690	690	690	
Rated impulse withstand voltage V		6000	6000	6000	6000	6000	6000	
Enclosure protection degree		IP20	IP20	IP20	IP20	-	-	
Phase loss protection		Yes	Yes	Yes	Yes	Yes	Yes	
Manual and automatic reset		Yes	Yes	Yes	Yes	Manual	Manual	
Temperature compensation		Yes	Yes	Yes	Yes	Yes	Yes	
Trip indication		Yes	Yes	Yes	Yes	Yes	Yes	
Test button		Yes	Yes	Yes	Yes	Yes	Yes	
Stop button		Yes	Yes	Yes	Yes	Yes	Yes	
Installation method		Plugged	Plugged	Plugged	Plugged	Independent	Independent	
Integrated auxiliary contact		1NO+1NC	1NO+1NC	1NO+1NC	1NO+1NC	1NO+1NC	1NO+1NC	
AC-15 380V/400V rated current A		1.5	1.5	1.5	1.5	1.5	1.5	
DC-13 220V rated current A		0.2	0.2	0.2	0.2	0.2	0.2	
Conductor cross section mm ²	Main circuit	Single-core or stranded wire	1~4	1~6	4~10	4~35	25~95	50~2×185
		Wiring screw	M3.5	M4	M4	M10	M8	M10
		Tightening torque (N·m)	0.8	0.8	0.8	0.8	1.2	1.2
	Auxiliary circuit	Single-core or stranded wire	1~2.5	1~2.5	1~2.5	1~2.5	1~2.5	1~2.5
		Wiring screw	M3.5	M3.5	M3.5	M3.5	M3.5	M3.5
		Tightening torque (N·m)	1.2	1.7	1.7	10	10	20

Protection characteristics

Item	No.	Multiples of setting current		Action time	Test conditions
Overload protection	1	1.05		Without action in 2 hours	Start from cold state
	2	1.2		Act within 2 hours	Start from hot state (after No. 1)
	3	1.5		Act within 2 minutes	Start after thermal equilibrium is reached under setting current
	4	7.2		$2s < T_p \leq 10s$	Start from cold state
Phase loss protection	5	Any two phases	The other phase	Without action in 2 hours	Start from cold state
		1.0	0.9		
	6	1.15	0	Act within 2 hours	Start from hot state (after No. 5)

Trip characteristics

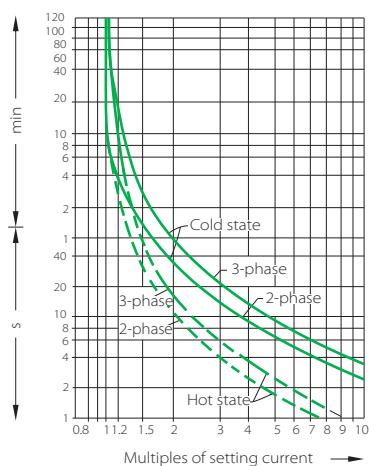

Thermal relay time Vs current characteristics curve (+20°C)

NXR thermal overload relay

Product front view

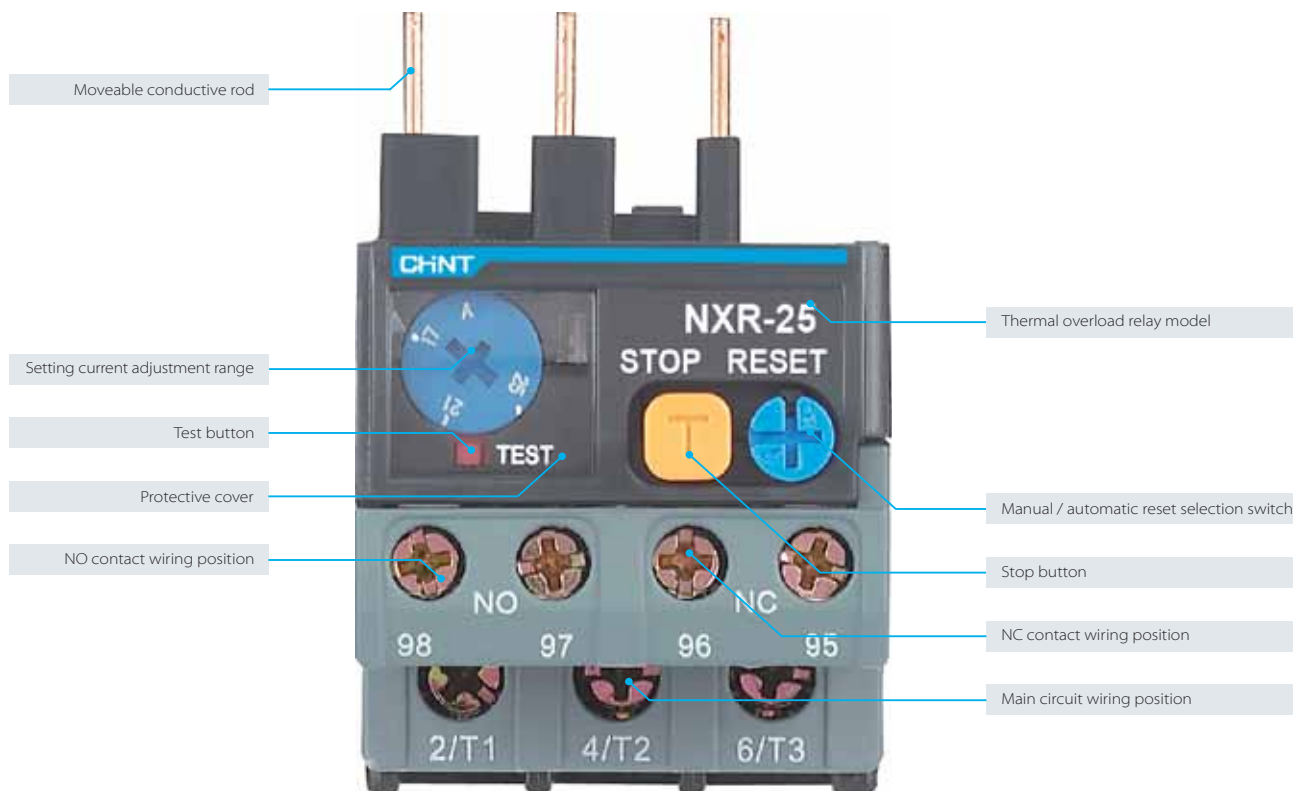

Dimensions and installation

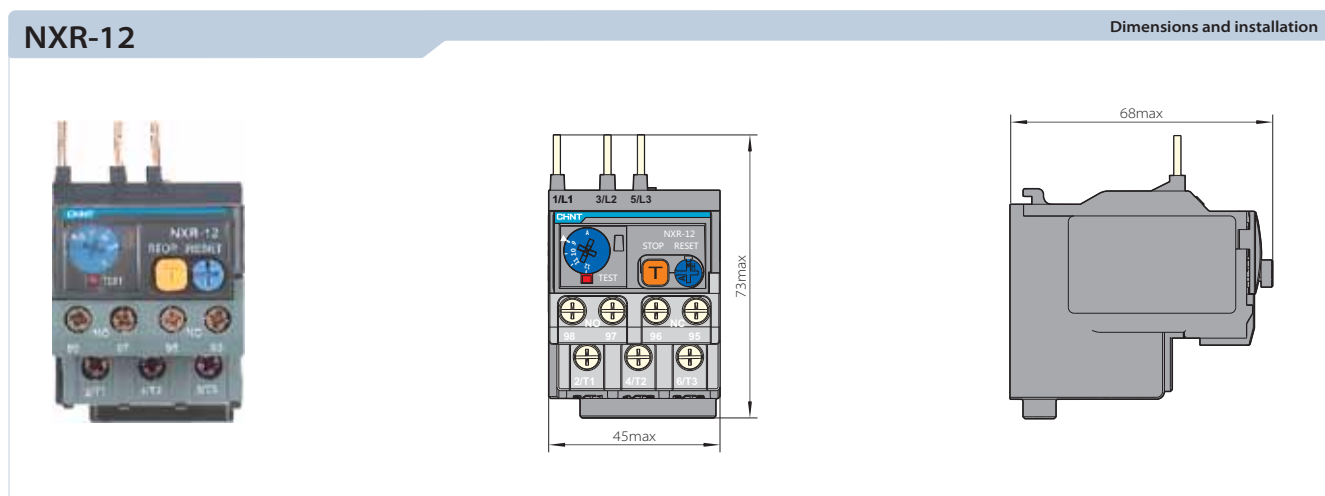

NXR thermal overload relay

NXR-25

Dimensions and installation

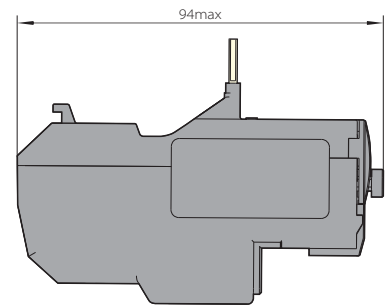
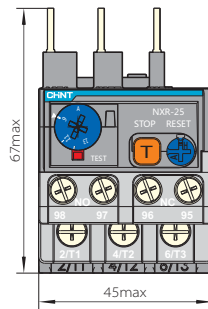

NXR-38

Dimensions and installation

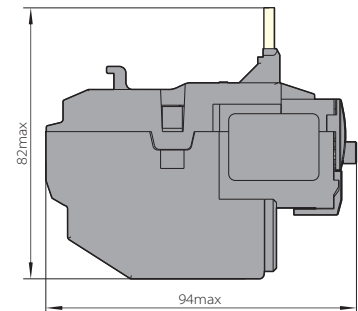
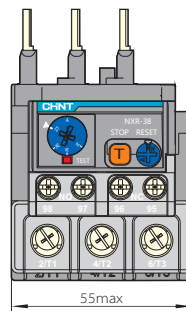

NXR-100

Dimensions and installation

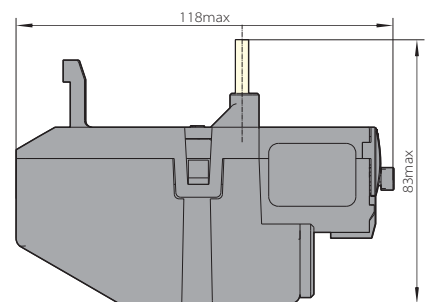
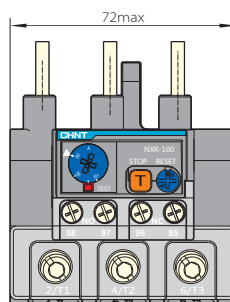

NXR thermal overload relay

NXR-200

Dimensions and installation

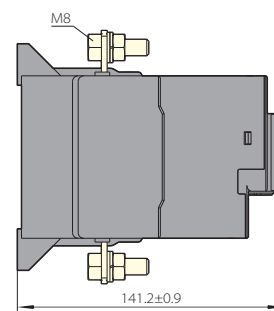
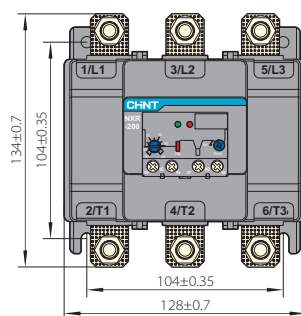

NXR-630

Dimensions and installation

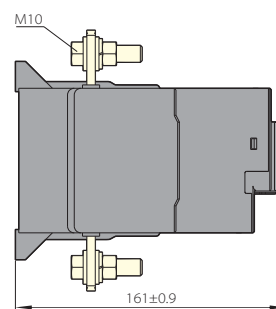
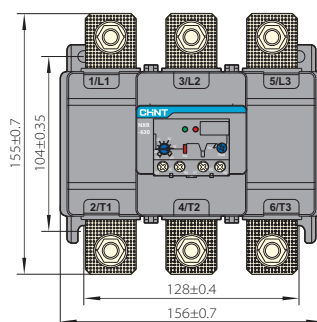

Sizes of combination with contactors

NXC-06M + NXR-12

Dimensions and installation

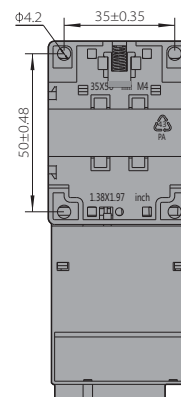
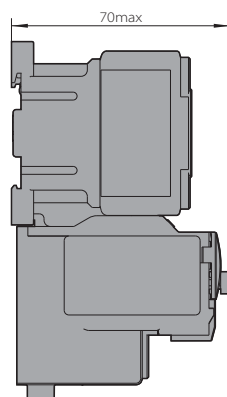
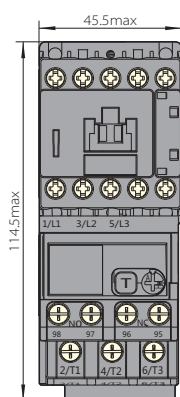

NXR thermal overload relay

NXC-09 + NXR-25

Dimensions and installation

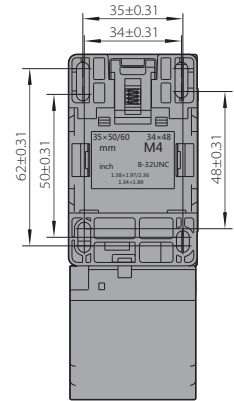
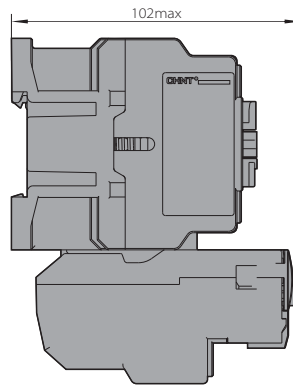
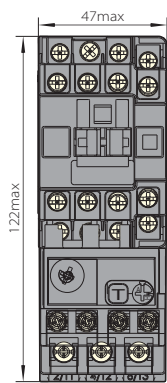

NXC-18 + NXR-25

Dimensions and installation

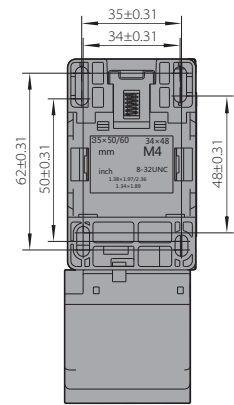
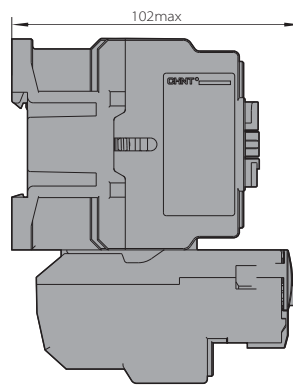
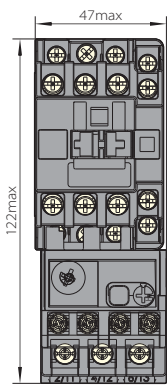

NXC-38 + NXR-25

Dimensions and installation

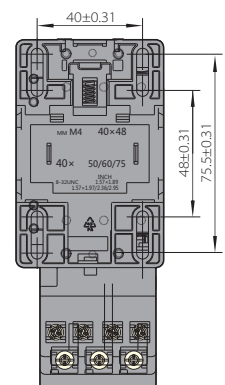
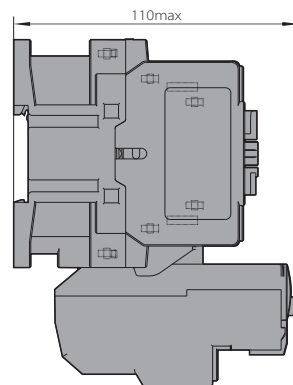
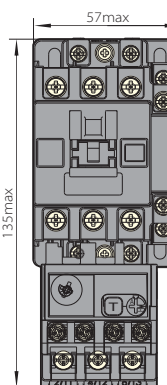

NXR thermal overload relay

NXC-38 + NXR-38

Dimensions and installation

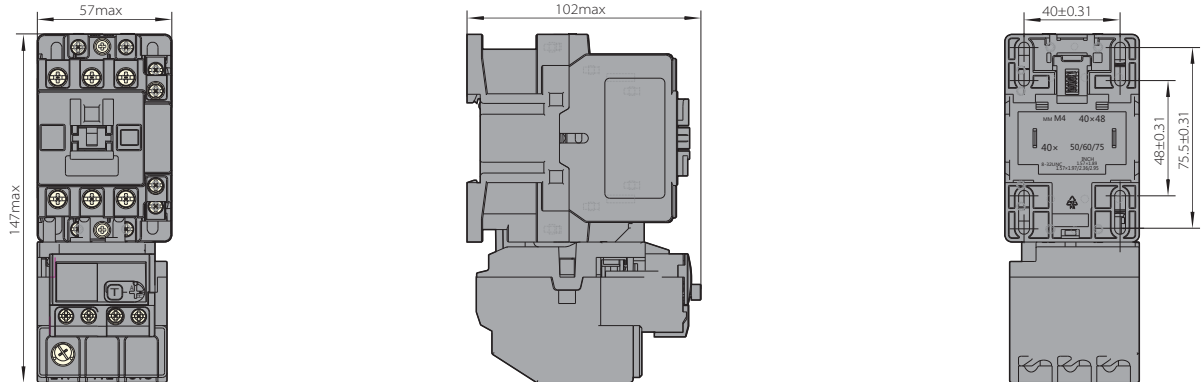

NXC-40 + NXR-100

Dimensions and installation

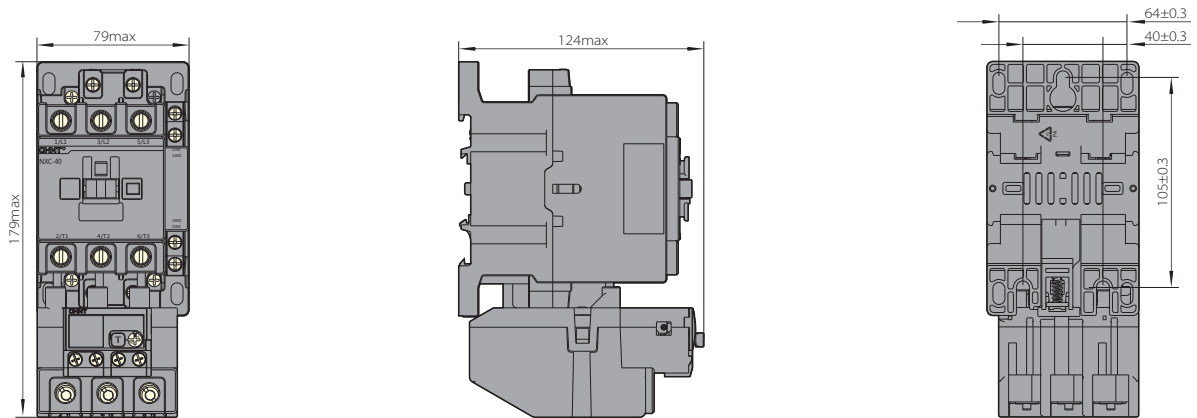

NXC-75 + NXR-100

Dimensions and installation

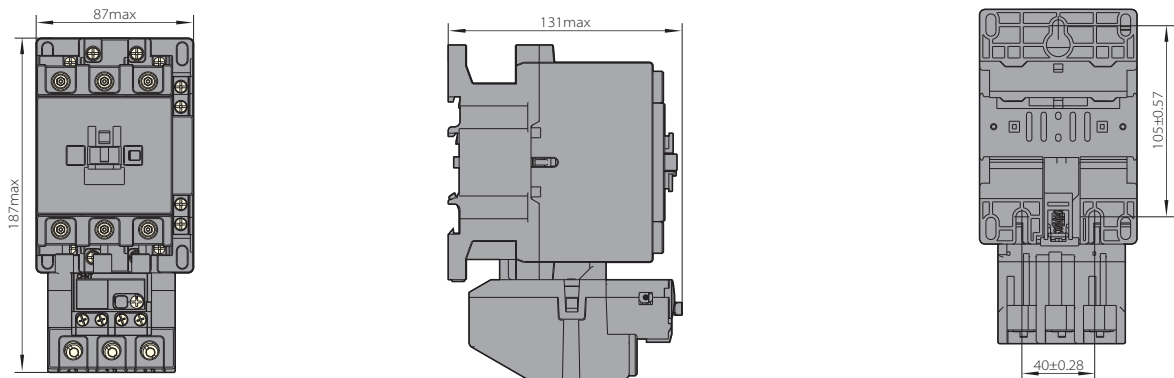

Wiring diagrams

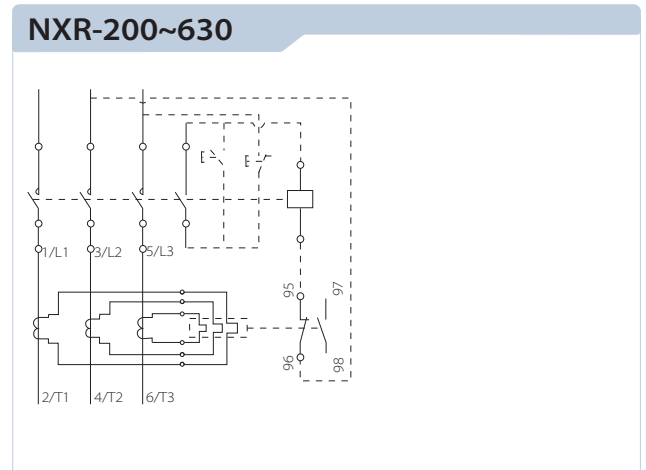
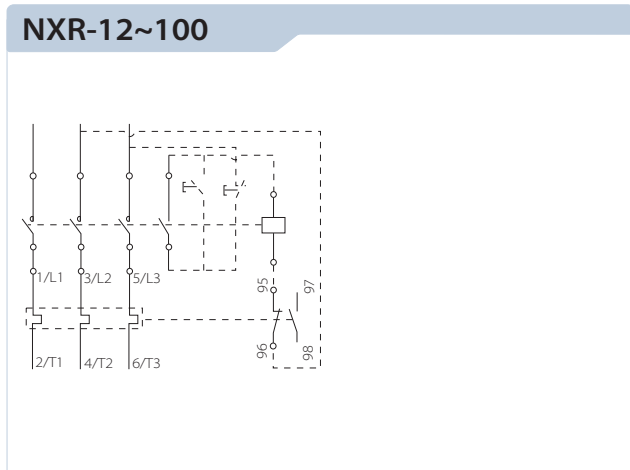

Annex I: Instructions for use in abnormal conditions

- IEC 60947-1 standard defines normal operation temperature range for products. Use of products in the normal range will not cause significant impact on their performance.
- At an operation temperature higher than +40°C, the tolerable temperature rise of products needs to be reduced. The rated operation current should be adjusted to prevent product damage, shortened service life, lower reliability, or impact on action characteristics. At a temperature lower than -5°C, impact of changes to the heat dissipation system on the action characteristics of the products should be considered.
- The temperature compensation coefficients at an ambient temperature higher than +40°C and lower than -5°C are given below. The compensation coefficients corresponding to -35°C and +70°C environments are given in the table below. No corrections are required for NXR-200 and NXR-630.

Operation ambient temperature		-35°C	+70°C
Temperature compensation coefficients for NXR-12, 25, 38, 100	Multiple of stable current	1.05	0.9
	Multiple of trip current	1.4	1.2

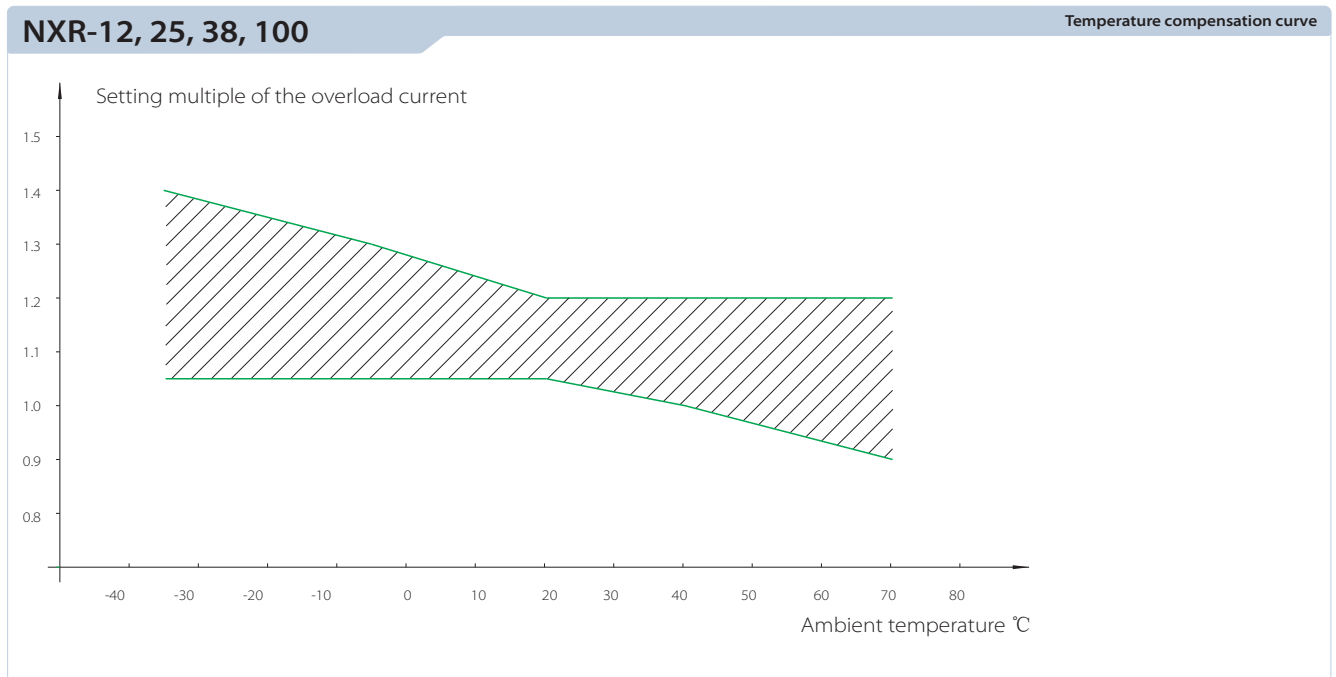

NXJ plug-in relay



Overview

Applicable scope

Three types of contacts (2Z, 3Z, and 4Z): complete range of AC/DC models; high contact reliability, applicable to PLC control; transparent dust cover encapsulation; supplied with sockets; status indicators with optional specifications.

Normal operation conditions and installation conditions

Temperature range	-40°C~+70°C
Relative humidity	Up to 95% at +25°C
Atmospheric pressure	86kPa~106kPa
Operation position	Any

Description

NXJ	A	220V	2Z	1	D
Relay model	Coil type	Coil voltage	Contact form	Connection method	Additional function
	A: AC	DC: 5V, 6V, 12V, 24V, 36V, 48V, 110V, 127V, 220V	2Z: Switching between two groups	1: Directly plugged	D: With status indicator
	None: DC	AC: 6V, 12V, 24V, 36V, 48V, 110V, 127V, 220V, 240V, 380V, 400V, 415V	3Z: Switching between three groups	6: Welded	B: With status indicator and surge suppressor (DC)
			4Z: Switching between four groups		

Model example:

NXJ-A220-2Z1D represents the following relay: rated control coil voltage: AC220V; contact form: switching between two groups (1NO + 1NC for each contact group, contact rated operation current 5A); directly plugged, with indicator function.

Parameters

Contact parameters

Contact form	2Z (C), 3Z (C), 4Z (C), 2ZH(C)
Initial contact resistance	50mΩ
Contact material	Silver alloy
Contact load (cosφ=1.0)	2Z, 3Z: 5A; 4Z: 3A; 2ZH: 10A (220VAC/28VDC)
Maximum switch voltage	250VAC/30VDC
Maximum switch current	2Z, 3Z: 5A; 4Z: 3A; 2ZH: 10A
Maximum switch power	2Z, 3Z: 1250VA/140W, 2ZH: 2200VA/280W 4Z: 750VA/84W
Electrical life (cycles)	1.2×10 ⁶ * (see the safety certification report for details)
Mechanical life (cycles)	2×10 ⁷

Performance and characteristics parameters

Insulation resistance		1000M Ω (500VAC)
Dielectric strength	Between contact coils	1500VAC, 1 min
	Between broken contacts	1000VAC, 1 min
Action time		\leq 15ms
Release time		\leq 15ms
Impulse (stability)		Acceleration 100m/s ² , pulse duration:1 ms
Vibration		Dual-amplitude 1mm, (10~55)Hz
Form of leading-out end		Directly plugged, welded
Dimensions (mm)		27.5x21.5x35.5

Coil parameters

Rated power	0.9~1W, 1.2~1.8VA
Pull-in voltage	DC \leq 75% rated voltage; AC: \leq 80% rated voltage
Release voltage	DC \geq 10% rated voltage; AC: \geq 20% rated voltage
Maximum voltage	120% rated voltage

Specification parameters

Rated voltage VDC	Action voltage VDC (\leq)	Release voltage VDC (\geq)	Coil resistance (20°C) Ω
5	3.75	0.5	28x(1 \pm 10%)
6	4.5	0.6	40x(1 \pm 10%)
12	9.0	1.2	160x(1 \pm 10%)
24	18.0	2.4	640x(1 \pm 10%)
36	27.0	3.6	1440x(1 \pm 15%)
48	36.0	4.8	2200x(1 \pm 15%)
110	82.5	11.0	14500x(1 \pm 15%)
127	95.3	12.7	17000x(1 \pm 15%)
220	165.0	22.0	39000x(1 \pm 15%)

Rated voltage VAC	Action voltage VAC (\leq)	Release voltage VAC (\geq)	Coil resistance (20°C) Ω
6	4.8	1.2	10.5x(1 \pm 10%)
12	9.6	2.4	44x(1 \pm 10%)
24	19.2	4.8	180x(1 \pm 10%)
36	28.8	7.2	380x(1 \pm 10%)
48	38.4	9.6	650x(1 \pm 10%)
110	88.0	22	3670x(1 \pm 15%)
127	101.6	25.4	4100x(1 \pm 15%)
220/230/240	176.0	44	15800x(1 \pm 15%)
380	304.0	72	39000x(1 \pm 15%)
400	320	80	43000x(1 \pm 15%)
415	332	83	46000x(1 \pm 15%)

NXJ plug-in relay

Accessories

Supplied sockets (optional)

Relay model	NXJ/2Z (D)		
Supplied socket model	RS-NXJ-2Z/C1	RS-NXJ-2Z/C2	RS-NXJ-2Z/C3
Socket dimensions (mm)	72x23x31	72x23x31	63x30.5x26
Socket lead form	Screw type wiring terminal (device type, rail type)		

Relay model	NXJ/3Z (D)		
Supplied socket model	RS-NXJ-3Z/C1	RS-NXJ-3Z/C2	RS-NXJ-3Z/C3
Socket dimensions (mm)	72x30x31	72x30x31	63x30.5x26
Socket lead form	Screw type wiring terminal (device type, rail type)		

Relay model	NXJ/4Z (D)		
Supplied socket model	RS-NXJ-4Z/C1	RS-NXJ-4Z/C2	RS-NXJ-4Z/C3
Socket dimensions (mm)	72x30x31	72x30x31	63x30.5x26
Socket lead form	Screw type wiring terminal (device type, rail type)		

Connection socket and fixing hook

Model \ type	Normal	With finger protection	With indication sign
NXJ/2Z □	RS-NXJ-2Z/C1	RS-NXJ-2Z/C2	RS-NXJ-2Z/C3
NXJ/3Z □	RS-NXJ-3Z/C1	RS-NXJ-3Z/C2	RS-NXJ-3Z/C3
NXJ/4Z □	RS-NXJ-4Z/C1	RS-NXJ-4Z/C2	RS-NXJ-4Z/C3
Fixing hook	NG102	NG102	NG103

Dimensions and installation

Body dimensions and installation sizes

2Z

Bottom wiring diagram

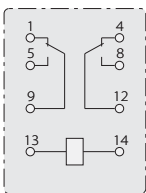

2Z

Bottom wiring diagram (with indicator)

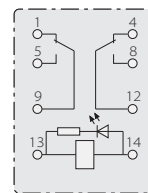

2Z

Bottom wiring diagram (with indicator and diode)

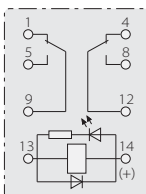

2Z

Installation hole position

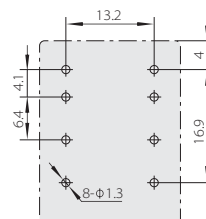

3Z Bottom wiring diagram

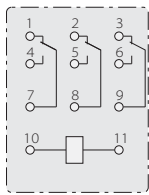

3Z Bottom wiring diagram (with indicator)

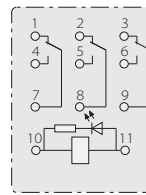

3Z Bottom wiring diagram (with indicator and diode)

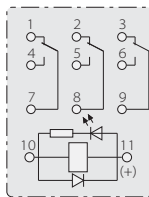

3Z Installation hole position

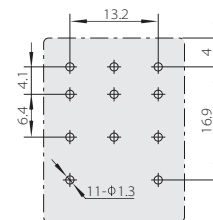

4Z Bottom wiring diagram

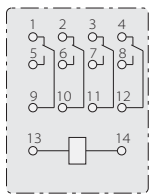

4Z Bottom wiring diagram (with indicator)

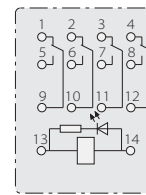

4Z Bottom wiring diagram (with indicator and diode)

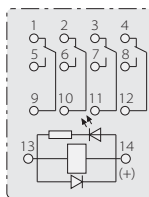

4Z Installation hole position

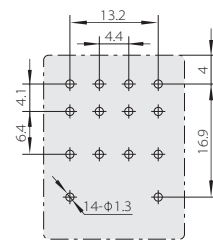

NXJ plug-in relay

2Z

Outline drawings (directly plugged)

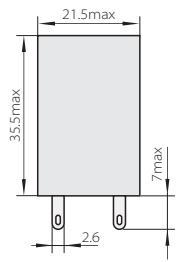

2Z

Outline drawings (welded)

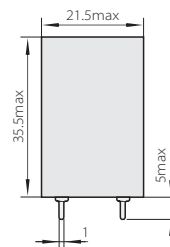

3Z

Outline drawings (directly plugged)

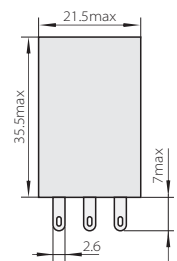

3Z

Outline drawings (welded)

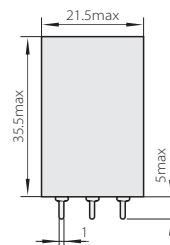

4Z

Outline drawings (directly plugged)

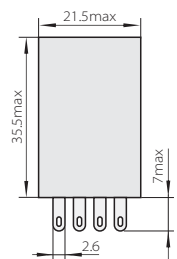

4Z

Outline drawings (welded)

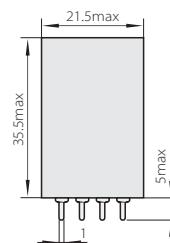

Socket outline and dimensions

RS-NXJ-2Z/C1



72x23x31 (mm)

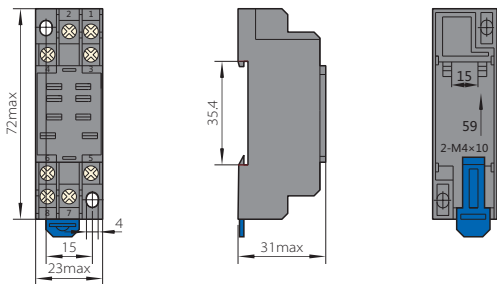

RS-NXJ-2Z/C2



72x23x31 (mm)

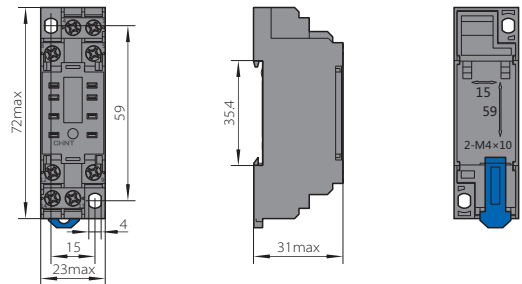

RS-NXJ-2Z/C3



63x30.5x26 (mm)

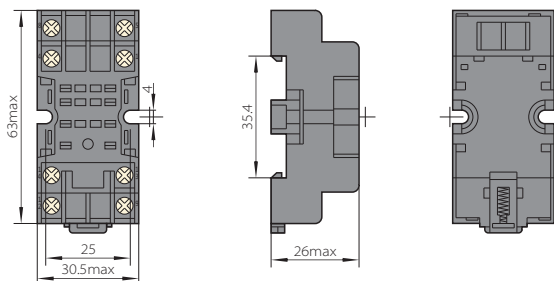

RS-NXJ-3Z/C1



72x30x31 (mm)

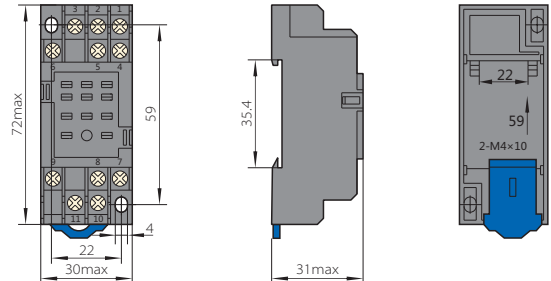

NXJ plug-in relay

RS-NXJ-3Z/C2



72x30x31 (mm)

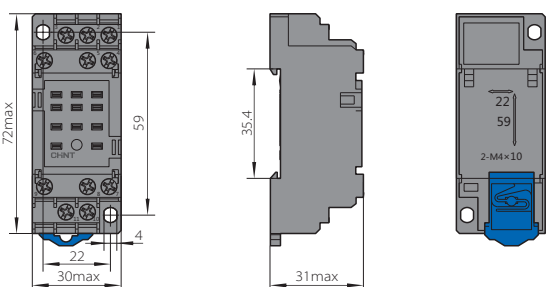

RS-NXJ-3Z/C3



63x30.5x26 (mm)

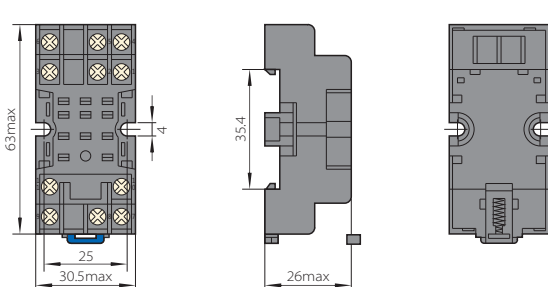

RS-NXJ-4Z/C1



72x30x31 (mm)

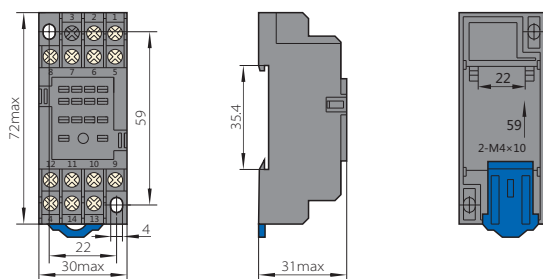

RS-NXJ-4Z/C2



72x30x31 (mm)

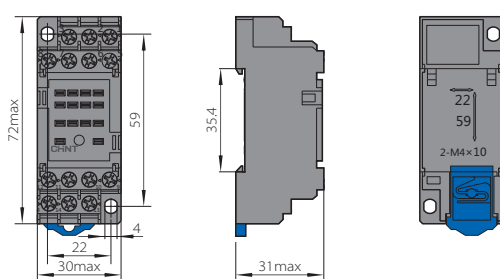

RS-NXJ-4Z/C3



63×30.5×26 (mm)

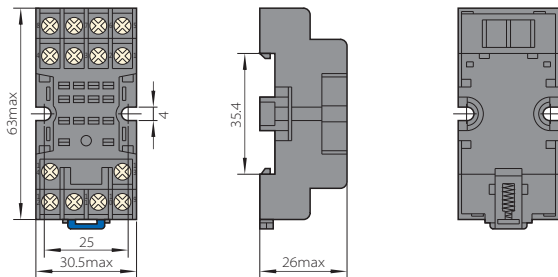

Hook outline

NG102



NG103



Socket + hook



Note

Note

Lined area for taking notes, consisting of multiple horizontal dashed lines.

Note

Dotted lines for writing content.

Europe

Italy

CHINT Electrics Europe S.R.L.

Add: Via A. Pacinotti 28, 30033 Noale (VE)
Tel: 0039 335 6265 032
E-mail: chint_eu@chint.com

Czech Republic

NOARK Electric Europe s.r.o.

Add: Sezemická 2757/2, 193 00 Prague
Tel: +420 226 203 120
Email: Europe@noark-electric.com
www.noark-electric.eu

Spain

CHINT Electrics S.L.

Add: Calle José Echegaray, Num 8.Parque Empresarial Las Rozas
Edificio 3, Planta 1º, Oficina 3.C.P: 28232 Las Rozas (Madrid)
Tel: 0034 91 636 59 98
Fax: 0034 91 645 95 82
E-mail: info@chintelectrics.es

Russia

ООО «Чинт Электрик»

Адрес: РФ, 109089, г. Москва, ул. Угрешская, д.2, стр.3, оф.17
Тел.: +7 495 665 6340
Факс: +7 495 665 6340
Email: cis@chint.com

North America

United States

NOARK Electric (USA) Inc.

Add: 2188 Pomona Blvd., Pomona, CA 91767
Tel: 626-330-7007
Fax: 626-330-8035
E-mail: nasales@noark-electric.com
na.noark-electric.com

Latin America

Brazil

CHINT Electrics South America Ltd

Add: Avenida Paulista nº 2073 – Conjunto Nacional – Edifício Horsa 1-
Conjunto Room 1407/1408 , Sao Paulo 01311-300
Tel: 0055-11-3266-7654
Fax: 0055-11-3142-9601
E-mail: chintlatinamerica@chint.com , xjie@chint.com

West Asia & Africa

U.A.E

CHINT West Asia & Africa FZE

Add: Office NO. LB182406, P.O.Box:263174, Jebel Ali, Dubai,
United Arab Emirates
Tel: 00971-48848286
Fax: 00971-48848287
E-mail: chintwaa@chint.com

Asia Pacific

China

Zhejiang CHINT Electrics Co.,Ltd

Add (Shanghai): Bldg.2, No.3255 Sixian Road, Songjiang 201614 P.R.China
Tel: 0086-21-67777706
Fax: 0086-21-67777777-88225
E-mail: asiapacific@chint.com , lwgen@chint.com



ZHEJIANG CHINT ELECTRICS CO.,LTD.

Add: No. 1, CHINT Road, CHINT Industrial Zone, North Baixiang,
Yueqing, Zhejiang, 325603, P.R.China
Tel: +86-577-61986198
Fax: +86-577-62775769 62871811
E-mail: global-sales@chint.com
Website: <http://next.chint.com/>



July 2016